

Article number: 2092763811B
Description: E+G Screws with ball
GN 606-M8-20-VN

Measures

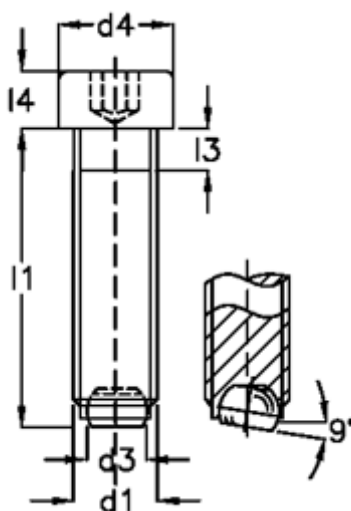

d1	= M8
d2	= 5.5
d3	= 4.5
d4	= 13
Internal hexagon	= 6.0
l1	= 20
l3	= 3.5
l4	= 8